

PYLE plus

**AM/FM RECEIVER & MP3/CD PLAYER
WITH DETACHABLE ANTI-THEFT FACE**

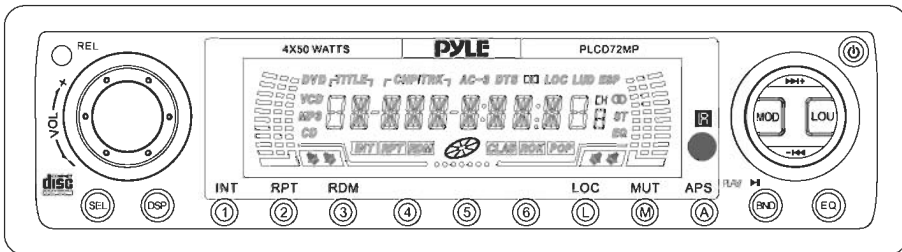

Owners Manual

PLEASE READ THIS MANUAL BEFORE USING

Welcome!

**Thank you for purchasing our company digital media player!
To operate the unit correctly, please read the owner's manual
carefully before using the unit. Keep these instructions and
retain this booklet for future reference.**

CONTENTS

Notes on Installation.....	3
Precautions.....	4
Wiring Diagram.....	5
Location of the Control.....	7
Basic Operation.....	8
Radio Operation.....	11
Location of the Remote Control.....	16
Remote Control Operation.....	17
Installation.....	20
Specification.....	22
Simple Troubleshooting Guide.....	23

Notes on installation

- ☞ The unit is designed for 12V DC , negative ground operation system only. Before installing the unit,
- ☞ make sure your vehicle is connected to DC 12V negative ground electrical system .
- ☞ The Negative battery terminal must be disconnected before making connections,which can reduce damaging the unit due to short circuit .
- ☞ Be sure to connect the color coded leads correctly according to the diagram. Incorrect connections may cause the unit malfunction or damage the vehicle's electrical system.
- ☞ Be sure to connect the speaker (-) leads to the speaker (-) terminal. Never connect the left and right channel speaker cables each other or to the vehicle body .
- ☞ Do not block vents or radiator panels. Blocking them will cause heat to build up inside and may result in fire .
- ☞ After the completion of the installation and begin to play the unit(including replacing the battery), please press the **RESET** button on the front panel with pointed objects(such as ball-point pen)to set the unit to initial status .

Precautions

☞ This unit can play the following discs only.

Type of disc	Label on the disc	Recorder material	Size of disc
MP3	MP3+CDC	Sound and moving Pictures	12cm/8cm
CD		Sound only	12cm/8cm

Note: ① The unit is compatible with .CD-RW, CD-R, PICTURE-CD version Disc.
 ② The manual conforms to Mp3 and CD; If no MP3 on some models, you should ignore them. While enjoying Mp3 and CD, the display will automatically identify the discs and indicate the corresponding words.

- ☞ Do not attempt to modify the unit, modifying the unit may cause an accident.
- ☞ Stop the vehicle before carrying out any operation that could interfere with your driving.
- ☞ Do not work in extreme high or low temperature inside the vehicle is between +60°C and -20°C before turning your unit on.
- ☞ To enjoy optimum sound and images while playing, handle the discs as follows:
 - Handle the disc by its edge to keep the disc clean, and do not touch the surface.

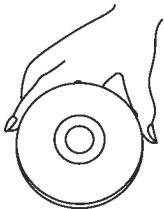

— Do not use your CDs with paste residue or ink attached.



— Do not use CDs with labels or stickers attached, which may leave a sticky residue while beginning to peel off. (Shown as picture)

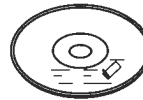

— Clean the discs with an optional cleaning cloth. Wipe each disc from the center out. (Shown as picture)

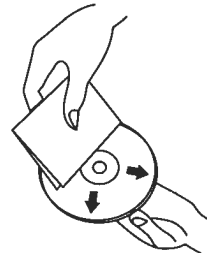

Wiring Diagram

STANDARD CONNECT

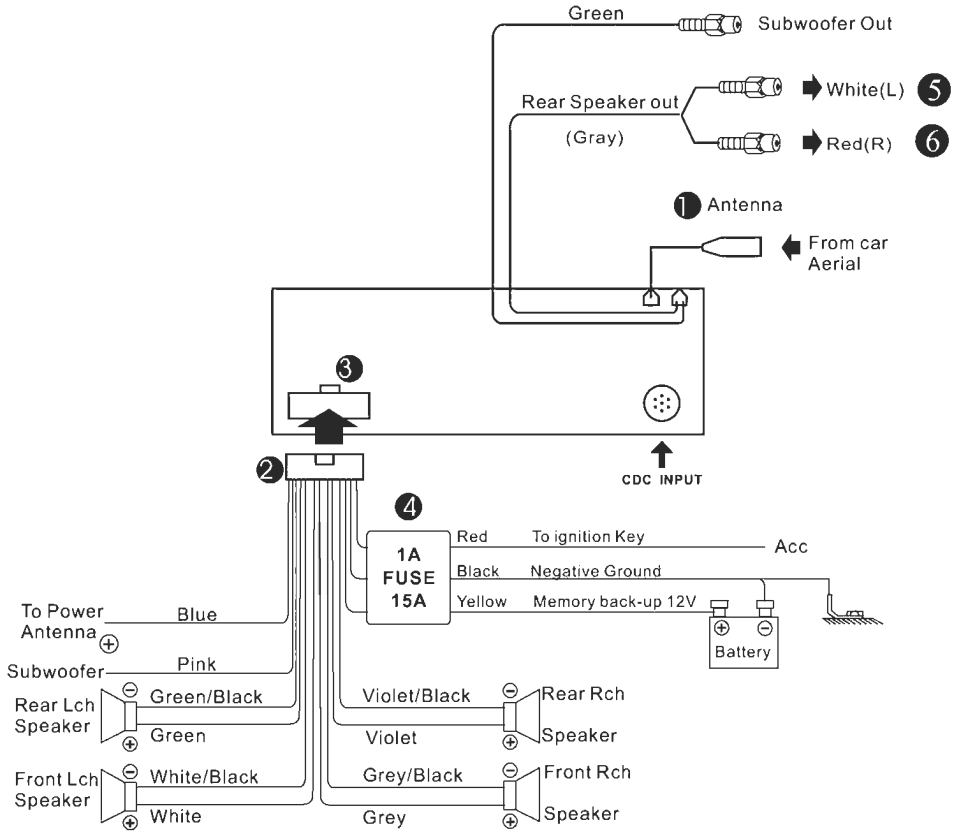

- | | |
|--------------------------|-----------------------|
| ① Antenna Receptacle | ④ Fuse Holder |
| ② Output Socket (male) | ⑤ Rear Speaker Out(L) |
| ③ Output Socket (female) | ⑥ Rear Speaker Out(R) |

Wiring Diagram

THE ESPECIAL CONNECT

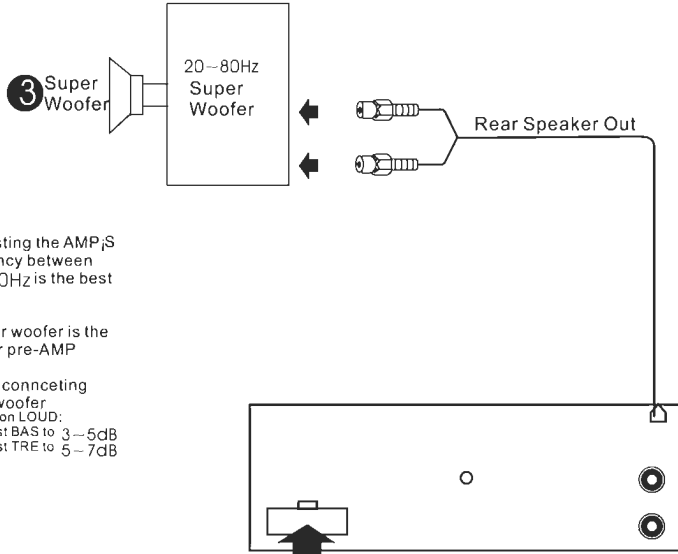

Note: 1. adjusting the AMP'S frequency between 20~80Hz is the best effect.

2. Super woofer is the best for pre-AMP

3. After connecting super woofer
 (1) Turn on LOUD;
 (2) Adjust BAS to 3~5dB
 (3) Adjust TRE to 5~7dB

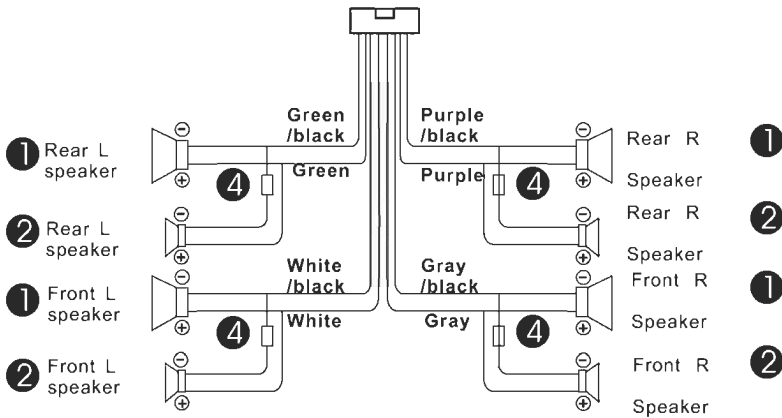

Location of the Control

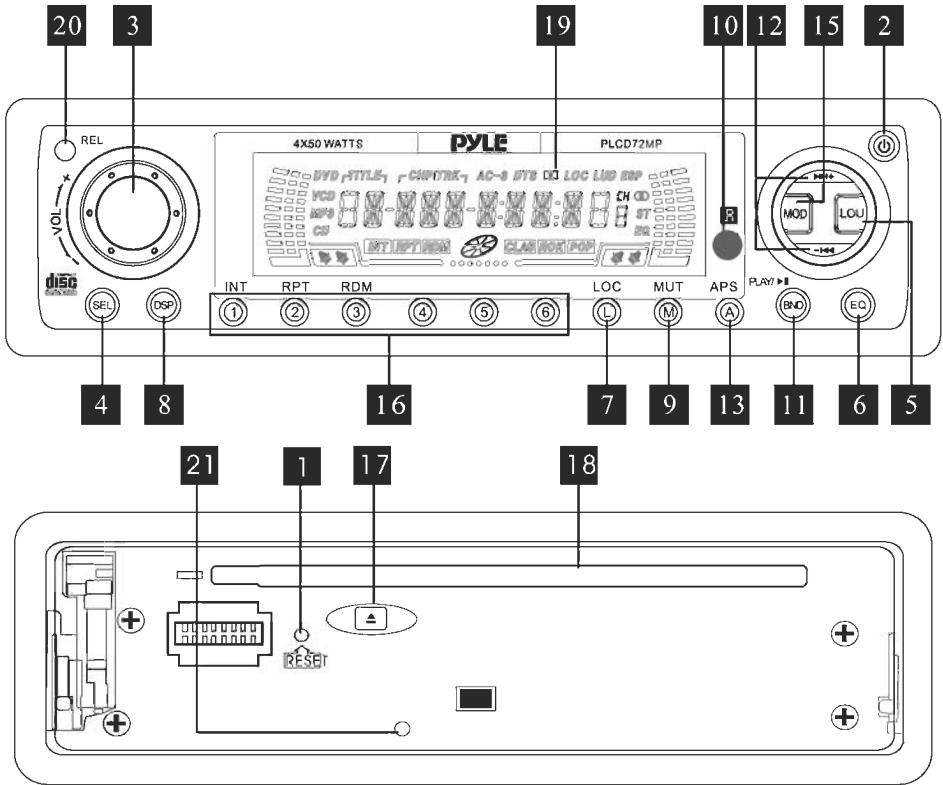

- 1** Reset Button
- 2** Power Button
- 3** Volume Control
Setting the sound

- 4** Characteristics
- 5** Loudness Button
- 6** P-EQ Button
- 7** LOC
- 8** Time-Displaying &
Adjusting Button
- 9** Mute Button
- 10** Remot Control
Receptor

- 11** Band Selector
- 12** Tuning/Selecting
Tracks
- 13** Preset Stations/AMS
- 14** —————
- 15** Mode Switch
- 16** Number Buttons
- 17** Eject Button
- 18** CD Slot
- 19** LCD Display
- 20** Release Button
- 21** LED Lamp

Basic Operation

XXXXXXXXXXXXXXXXXXXXXXXXXXXX

Initial system start-up

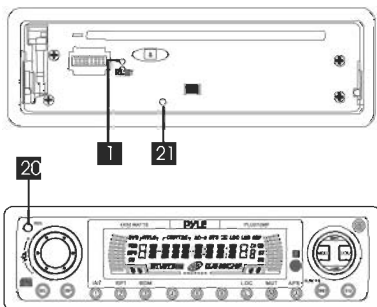

1. Operating the unit for the first time or after replacing the car battery, you must reset unit, press **1** (RES) button with a pointed object (such as a ball point pen) to set the unit to initial procedure.

★ Note :when some errors occur in the LCD display you can also press RESET button to resume to normal And it will erase the clock setting and some memorized functions.

XXXXXXXXXXXXXXXXXXXXXXXXXXXX

Turning the Unit on /off

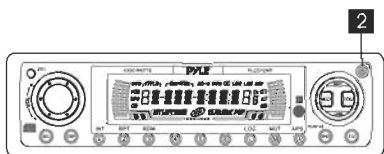

Press **2**(PWR) button to turn on the unit ,and press it again to turn off the unit.

★Note :After the unit is off ,if the volume level is higher than it is in initial setting ,it will resume, to initial status;if it is lower than that in initial status ,it will store in the status which you set.

XXXXXXXXXXXXXXXXXXXXXXXXXXXX

Vol /Bass /Tre /Bal (L-R) /Fad(F-R)Selector

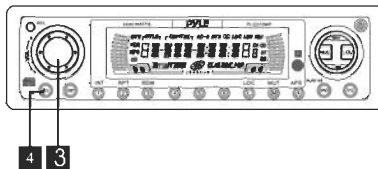

3.For Volume Control **3** ,rotate, vol knob clockwise to increases the sound level, and rotate it anticlockwise to decrease the sound level.

4.Repeatedly press **4** (SEL)button to select the desired mode in the following order:

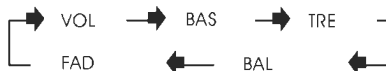

★ Note :After selecting the desired mode, you can adjust the current level by rotating the **3** (VOL) knob.

★ Note :If you don't adjust **3**(VOL) knob within 5seconds after selecting the desired mode the unit will automaticall return to the current mode being displayed.



XXXXXXXXXXXXXXXXXXXXXXXXXXXX

Basic Operation

XXXXXXXXXXXXXXXXXXXXXXXXXXXX

Turning Loudness On/Off

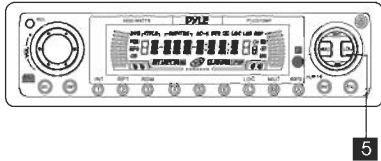

5. Press **5** (LOU) button to increase the low frequency , This can improve the sensitivity for your ears And *LOUD* appears in the LCD when the loudness mode is activated. (See the picture) press it once more to shut down the LOU function.

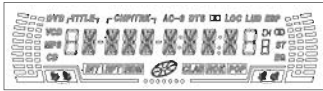

XXXXXXXXXXXXXXXXXXXXXXXXXXXX

Setting P-EQ

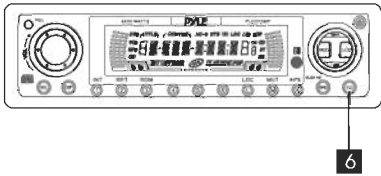

6. While listening to the popular music classic music and rock music , you can adjust the sound quality to make it perfect by pressing **6** (EQ) button the procedure is as follows.

Pop mode is selected when **6** (EQ) button is first pressed and *POP* appears in the display.

★CLASSIC mode is selected when pressing **6** (P-EQ) button at the second time ,and *CLAS* appears on the LCD .



★ROCK mode is selected when pressing **6** (P-EQ) button at the third time and *ROCK* appears in the display.

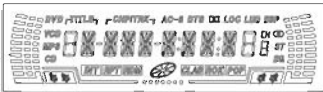

★Press **6** (P-EQ) button at the fourth time to turn off the P-EQ system.

Note :Bass mode and Trble mode return to initial setting when P-EQ system is on *BASS* and *TREBLE* disappear

XXXXXXXXXXXXXXXXXXXXXXXXXXXX

LO /DX Selector

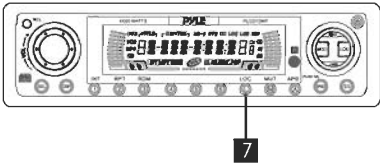

7. Press **7** (LOC) button to select strong or weak station reception
 ★It is set to LOC mode when **7** (LOC) button is first pressed *LOC* appears and only local station is available.

XXXXXXXXXXXXXXXXXXXXXXXXXXXX

Basic Operation

XXXXXXXXXXXXXXXXXXXXXXXXXXXX



- ★ It is switched to DX mode when **7** (LOC) button is pressed again. Both distance and local stations can be received.

Note:①. The initial mode is DX mode, No. **DX** appears in LCD.
②. Loc is functional only in selecting stations.

XXXXXXXXXXXXXXXXXXXXXXXXXXXX

Displaying and Adjusting Time

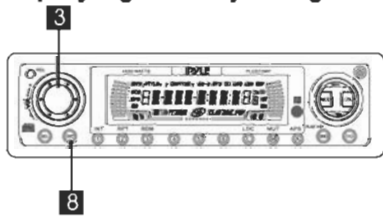

- 8. Time Displaying: Press **8** (DSP) button and the current time is displayed, and it returns to original status after 5 seconds or press the button again.
- Time Adjusting: press and hold (SEL) button until the two points in the middle of the clock stop blinking, you can rotate **3** (VOL) knob adjust hours and minutes.

XXXXXXXXXXXXXXXXXXXXXXXXXXXX

XXXXXXXXXXXXXXXXXXXXXXXXXXXX

Mute Function

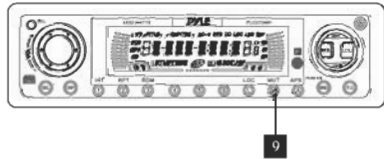

- 9. Press **9** (MUT) button to cut down the sound output, **MUTE** appears in the LCD (Press it again) to revert to previous volume level.

XXXXXXXXXXXXXXXXXXXXXXXXXXXX

Sensor

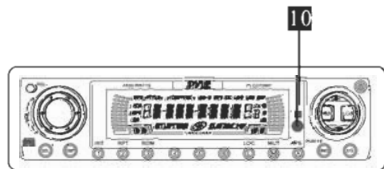

- 10. Receptor for the card remote commander. (for remote control version only).

Note: This window is used for the unit with remote control function. without this function you should ignore the operation contents about remote control function.

XXXXXXXXXXXXXXXXXXXXXXXXXXXX

Radio Operation

XXXXXXXXXXXXXXXXXXXXXXXXXXXX

Band Selector



11

1. Press **11** (BAND) button repeatedly to select bands in the following order:

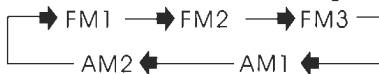

During CD mode **PLAY/** button to suspend the playback.

XXXXXXXXXXXXXXXXXXXXXXXXXXXX

Selecting Tracks/F.F/REW

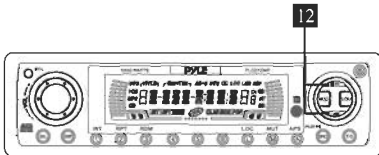

12

2. Manual Tuning: press **12** + **FF** or **REW** button continuously to select a station upward or downward respectively.
Automatic Tuning: press and hold **12** + **FF** or **REW** button for more than 3 seconds, the radio automatically searches, a station upward or downward respectively and plays when it finds a station.

XXXXXXXXXXXXXXXXXXXXXXXXXXXX

Scanning/Memorizing Station Automatically

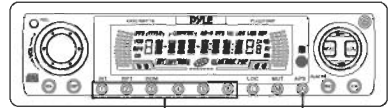

16

13

3. press **13**(APS) button to scan each stored station 10 seconds respectively which stored in **16** (1-6) number buttons when AMS mode is carried out, **INT** appears on display. (See the picture). you also can press the corresponding number button or AMS button when your desired station is charged. It starts playing that station,

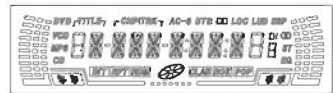

Press and hold **13**(APS) button for more than 3 seconds to activate automatically memory storing function. The radio automatically selects a station and has it stored in any one of the number buttons **16**(1-6)

★ **Note:** The unit can be stored up to 6 stations for each band. Regarding the function of number button refer **16** number buttons for details.

Radio Operation

XXXXXXXXXXXXXXXXXXXXXXXXXXXX

Mode Selector

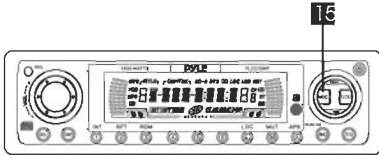

Press (MOD) button to select radio mode or playback mode. when in radio ,press (MOD) button for 2 seconds to turn on/off CD changer function. when in CD mode,press (MOD) button for 2 seconds to turn on/off ESP function.

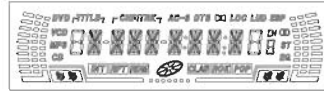

You can store up to 18 FM stations up to 12 AM stations.

★**Note:** Working at 3 band for Europe ,AM represents MW and LW.

Number Buttons

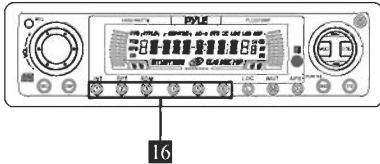

6. Number button can help you store your favorite station by pressing any one of the number buttons ,you can follow the steps as below:
 Press and hold any number button **16** (1-6) until CH appears in the LCD display when receiving a station ,And now the station is already stored in the corresponding number button.

XXXXXXXXXXXXXXXXXXXXXXXXXXXX

MP3 CD Operation

1. While listening to (or watching) CD just insert a Cds (with labeled side up) into the CD SLOT **18** ,the mechanism, will automatically switch on If a Cds is loaded press **19** (MOD) button to start the playing.

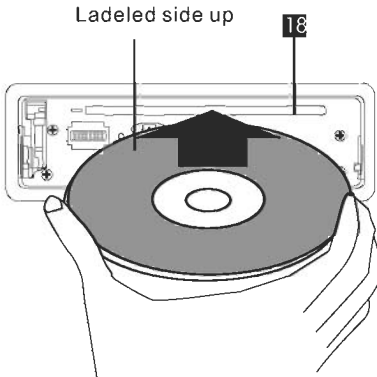

Note: During LCD Mode press and hold button to switch on /off ESP function.

★ While listening to (or watching)MP3 just insert Cds into the CD SLOT **18** the mechanism will automatically switch on And the menu on the disc will display to select playing pictures or music.

2. Press **12** **+** **|||** **|||** **←** to choose your favorite track up ward or down ward respectivel ,Press and hold **12** **+** **|||** **|||** **←** button to fast forwardor rewind the track up ward or downward respectively.

Selecting Tracks/F.F/REW

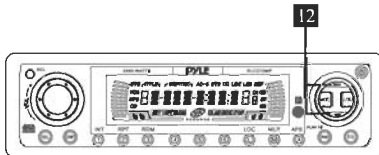

MP3 CD Operation

Playing Tracks Repeatedly



3. Press **16** **RPT** **2** button to perform repeat playing function when you need to repeat playing the track you like

★ During CD version press **RPT** **2** button at the first time to repeat playing the same track **RPT** appears (Shown as picture), which indicates repeat playing one track starts press **RPT** **2** button again to stop repeat.

Scanning Tracks Automatically



4. During play back press **16** **INT** **1** button ,one of the number button **16** to play the first 10 seconds of each track on the disc ,the display will show **INT**, track number and elapsed time (See the picture).which indicates INT function is already activated,



Press **RDM** **3** button once more to normal play back

★ Note: INT doesn't work during playing MP3.

Playing Tracks in Random Order

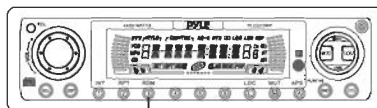

5. During playback press **16** **RDM** **3** button ,and **RDM** appears on the display (See the picture),which indicates RDM function is carried out ,The unit plays any track at random ,Press RDM omce more to return to return to normal playback mode.



★ Note: RDM doesn't work during playing MP3.

MP3 CD Operation

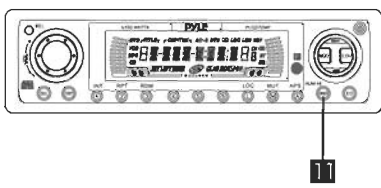
Pause the playback





Note: Please use original disc for this product poor quality disc might damage the lens If the product automatically locked press (MOD) to change to radio mode and press the EJECT button for 3 seconds to eject the disc.

6. During playback, press **11** **PLAY/PAUSE** button to suspend the playback.  mark stops running in the display. To return to normal play mode, press it again, and  mark runs accordingly.

★ Note: Press **17** **EJECT** button not to eject disc during suspending mode, operate the function after canceling suspend

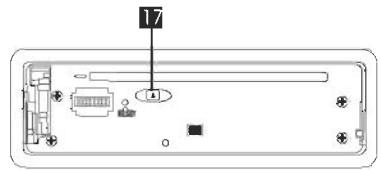
Eject a Cds



7. Press **17** **EJECT** button () to eject the disc. **OPEN** will appear on display.

Location of the remote control

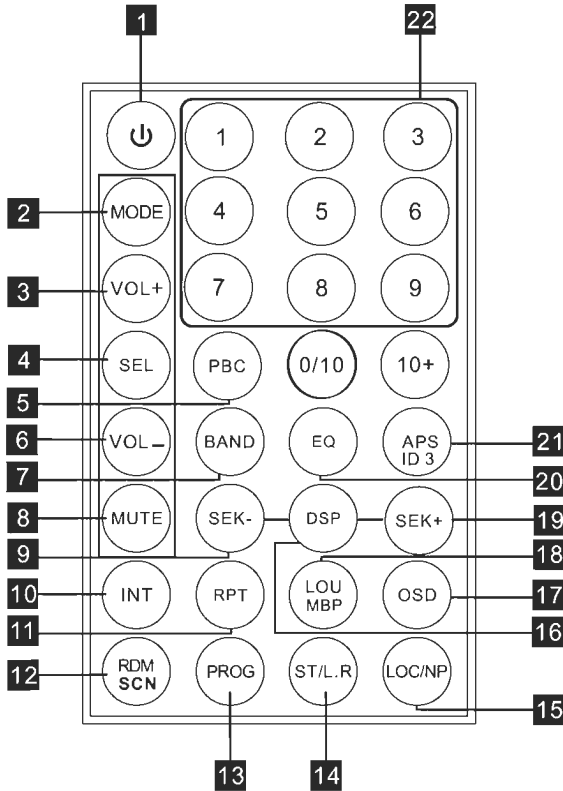

- | | | | |
|-----------|--|-----------|---|
| 1 | Power Switch | 13 | Program Playing |
| 2 | Mode Switch | 14 | MO/ST Selector |
| 3 | Volume Control (Vol +) | 15 | Local/Distance/PAL/NTSC Switches |
| 4 | Setting the Sound Characteristics | 16 | DSP Playing Time -Setting |
| 5 | Playing PBC (menu) | 17 | On Screen Display |
| 6 | Volume Control (Vol -) | 18 | Loud |
| 7 | Band Switch (CD Pause the Playback) | 19 | Tuning/Selecting Tracks/F.F/REW (SEEK-) |
| 8 | Mute Button | 20 | Setting P-EQ |
| 9 | Tuning/Selecting Tracks/F.F/REW(SEEK+) | 21 | Memorizing Stations Automatically |
| 10 | Intr Playing | 22 | Number Buttons |
| 11 | Repeat Playing | | |
| 12 | Random Playing | | |

Remote Control Operation

Replacing the Battery

★ When the range of the operation of the card remote control becomes short or no functions while operating Replace the battery with a new button cell ,Make sure the battery polarity before replace
 1.Pull out the Battery Holder while pressing the Stopper ①

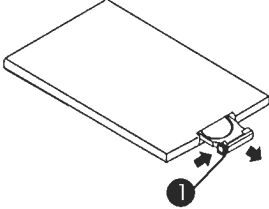

2.Put the button-type battery (+) mark up ward into the Battery Holder.

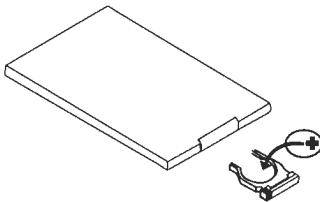

3.Insert the Battery Holder into the Remote Control.

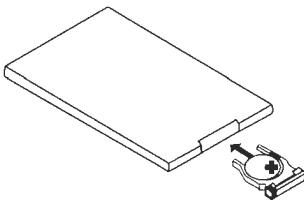



Note:Some models are not equipped with remote control you should ignore the contents about remote control.

★ 1.Power Button

— Press **1** () button to turn On/Off the power

★ 2.Mode Switch

— Press **2**  button to select radio mode or play back mode During CD mode ,press and hold **2**  button to switch on /off ESP function.

★ 3.Volume Increasing/Decreasing

— Press **3**  (VOL+) button to increase the volume level respectively.

★ 4.VOL /BAS/TRE/BAL/FAD Selector

— Repeatedly press **4** (SEL) button to select the desired mode in the following order:

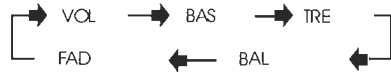

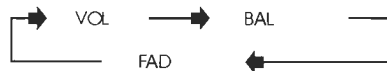

Note:After selecting your desired mode ,you can adjust the current mode being displayed by using (VOL+orVOL-)buttons ,when P-EQ mode is activated press SEL button to select the modes,And Bass/Treble mode **6** are invalid.(shown as below)



Remote Control Operation

★ 7. Band/system switch



- During radio mode ,press  to switch Receiving Band.
- During the player mode ,press  button to suspend the Play back To return to normal play mode press it again.

During CD mode ,press  button to suspend the playback.

★8.Mute Button

- Press **8** (MUTE button to cut down the sound output.press it once more to resume the previous sound level.

★ 9.Tuning /Selecting Tracks FastRewind /Forward

- During radio mode ,continously press  button to manul search a station d-ownward or upward respec-tively;if press and hold  button for more than 3 seconds ,the radio will automatically sta-tion downward or upward respectively unit it finds a station.
- During the playing mode ,press and hold  button to fast rewind or fast forward for you to reach your desired track quickly,when discontinuously,press

 Button ,you can Select your desired portion downward or upward respectively.

★ 10.Intr Playing

10 Note:please refer to page 14 aboutthe specific function.

★ 11.Repeat Playing

- During CD mode firstly press **11** (RPT)to repeathe current track being played;press it again to cancel the repeating functional.

Note:In CD mode The initial procedure is repeat playing all the tracks.

Remote Control Operation

★ 12.Random Playing

During the playing mode ,press **12** SCN /RDM (Viz .The unit plays tracks out of turn)

★ 16.DSP

press and hold this button to adjust to the best sound eflec

★ 18.play Time-setting.t.

★ 20.P-EQ Button

—Note: **20** please Refferto page 9 about the specific function.

★ Ams Button

—Note: **21** Ams Button please Reffer to page 12 about the specific function,

★ Number Buttons

— During radio mode ,you can select one of the 6 stored station on each hand by pressing any one of the number button **5**

— During CD mode you can select any track directly by using **5** number button(0~10+).For example ,if you need the fifteenth track ,you can fist press button 10+ and then press button 5 ,the corresponding tarck (15)willbe played.

When button 10+is first pressed it works as 10+it works as20+ when pressed at the second time ,the third time....30+ and the like

Installation

XX

Parts List (The number in the list are keyed to those in the instructions)

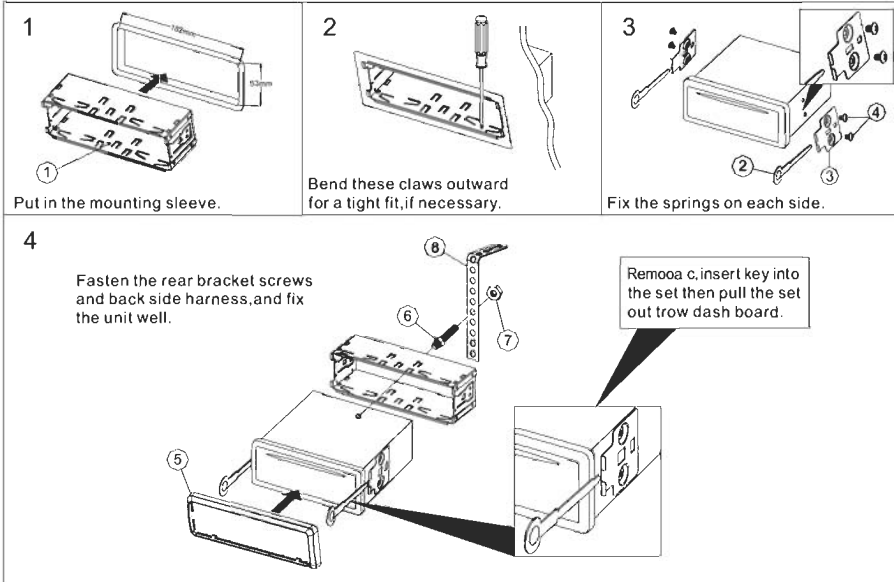
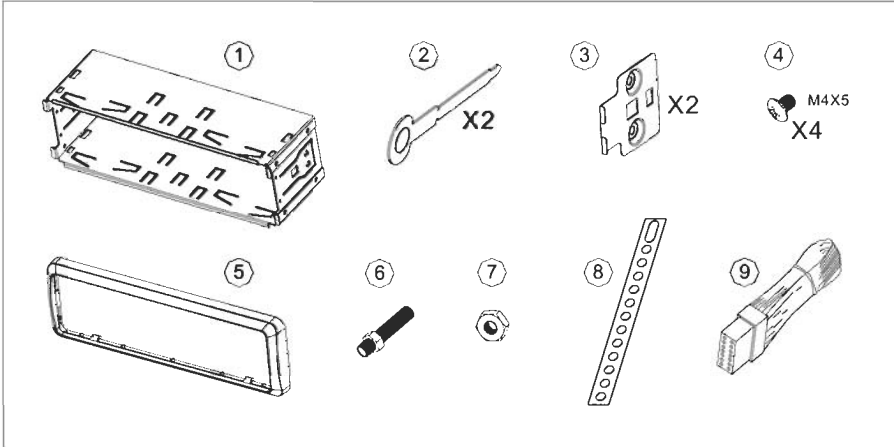

Installation

XX

Mounting Example ②

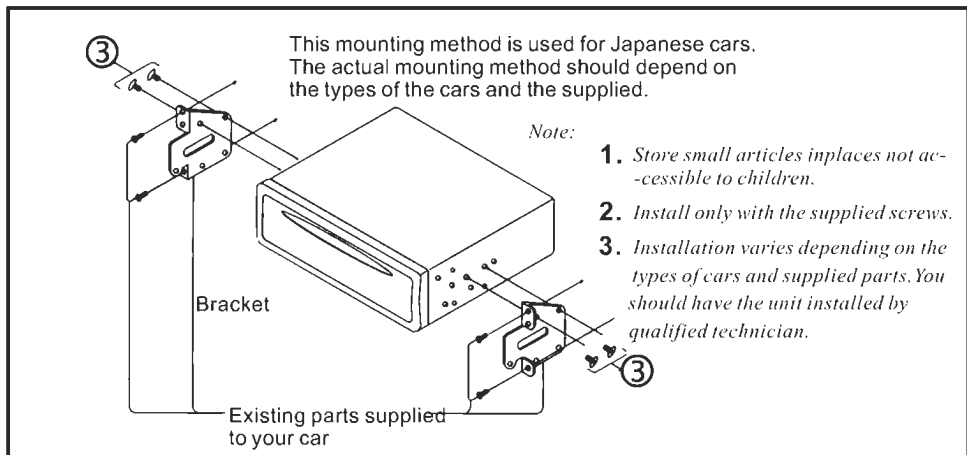

DETACHING THE FRONT PANEL

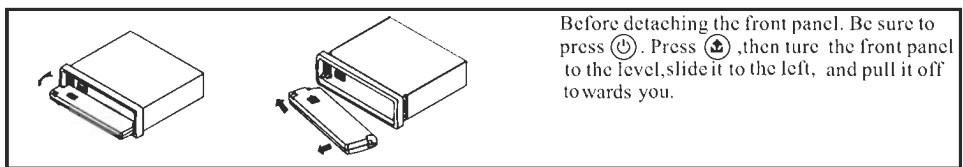

REPLACING THE FRONT PANEL

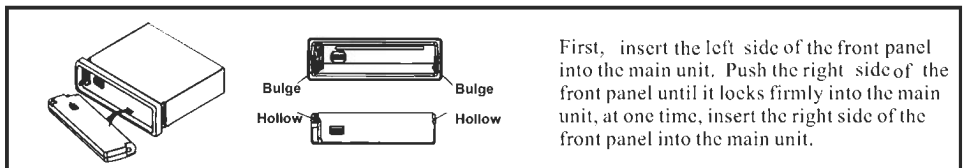

PRECAUTIONS

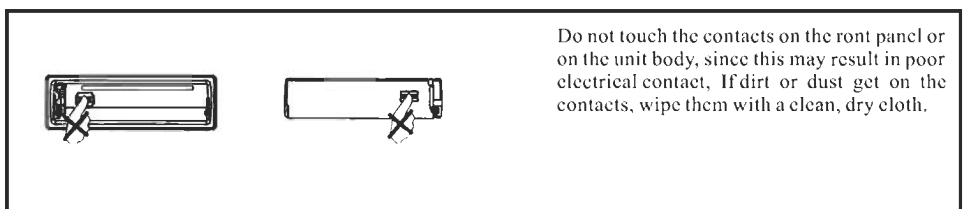

Specifications

General

Power Requirements.....14.4VDC
Load Impedance.....4 Ω
Max. Power Output.....50Wx4
Tone Controls.....±8dB(Bass 100Hz, Treble 10KHz)
Dimensions..... Approx. 192x178x50mm(dxwxh)
Mounting Dimensions..... Approx. 169x182x53mm(dxwxh)
Weight..... Approx. 1.75kg

Mp3 Deck Section

Discs PlayedMP3,CD,CD-R,PICTURE-CD
Video System..... AUTO/PAL/NTSC
Mounting Angle.....0 to +/-30"

Audio Section

Maximum Output level..... 2Vrms(+/-3dB)
Frequency Response..... 20 to 20Khz
Signal-to-noise Ratio..... 85dB
Separation..... 80dB

AM Tuner Section

Frequency Range.....522-1620(Europe/China),530-1710(U.S.A)
IF Range450KHz
Usable Sensitivity(-20dB).....25dB

FM Tuner Section

Tuning Range.....87.5-108(Europe/China),87.5-107.9(U.S.A)
IF Range10.7MHz
Usable sensitivity (-30dB).....15dB
Signal-to-noise Ratio60dB
Stereo Separation.....30dB(1KHz)
Frequency Response.....30~15000Hz

XX

Note: Due to continuous product improvement, specifications and design are subject to change without notice.

